

# Electro-Optical Modulators

## Operating Manual

# Table of Contents

<b>TABLE OF CONTENTS</b> .....	<b>2</b>
<b>1 HANDLING INSTRUCTIONS</b> .....	<b>3</b>
1.1 UNPACKING STEPS .....	3
1.2 WARNINGS TO AVOID DAMAGE .....	9
<b>2 INSTRUCTIONS BEFORE USE</b> .....	<b>10</b>
2.1 CLEANING .....	10
2.1 OPTICAL INTERFACES .....	10
2.1 ELECTRICAL INTERFACES .....	12
2.2 MAXIMUM RATINGS .....	14
<b>3 MEASUREMENT PARAMETERS</b> .....	<b>15</b>
3.1 INSERTION LOSS (IL) .....	15
3.2 STATIC EXTINGUISH RATIO (SER) .....	18
3.3 HALF-WAVE VOLTAGE ( $V_{\pi}$ ) AT LOW FREQUENCIES (KHZ).....	20
3.4 RESIDUAL AMPLITUDE MODULATION (RAM) .....	22
3.5 POLARIZATION EXTINGUISH RATIO (PER).....	23
3.6 POLARIZATION DEPENDENT LOSS (PDL).....	25
3.7 ELECTRICAL RETURN LOSS $S_{11}$ & ELECTRO-OPTICAL BANDWIDTH $S_{21}$ .....	26

# 1 Handling instructions

## 1.1 Unpacking steps

- 1) Put the blister pack on a flat surface to open it:



Fig. 1

- 2) To open the blister pack either peel off or cut the orange label located on the front:



Fig. 2

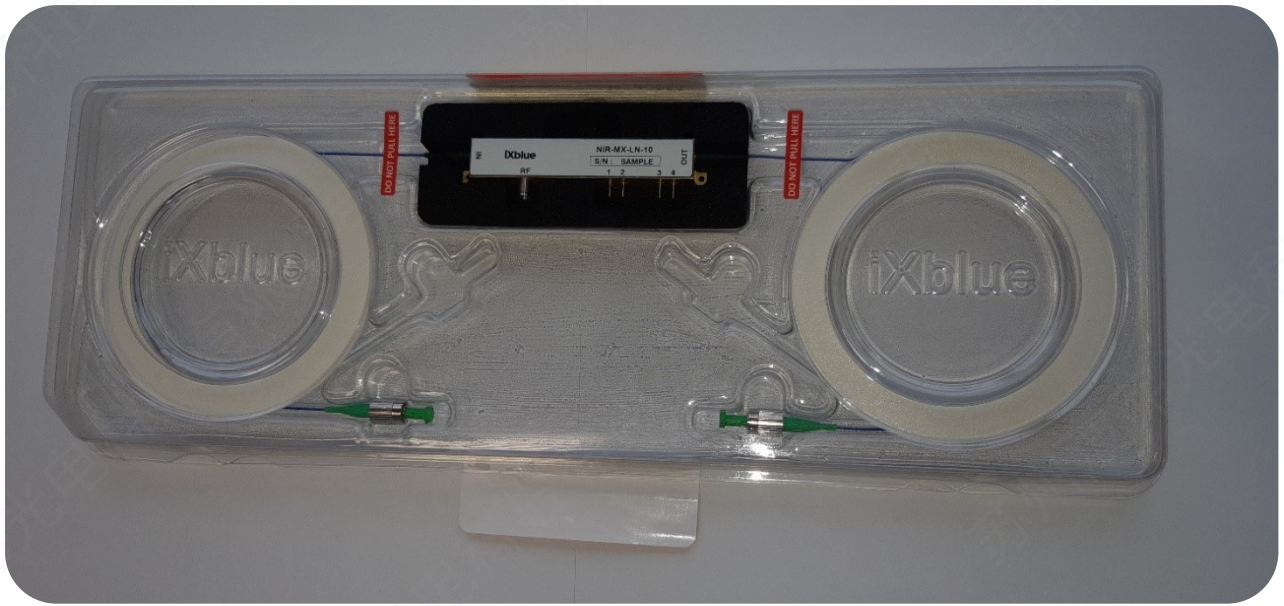

Fig. 3

3) To open the blister pack, you can use the notches on the front:

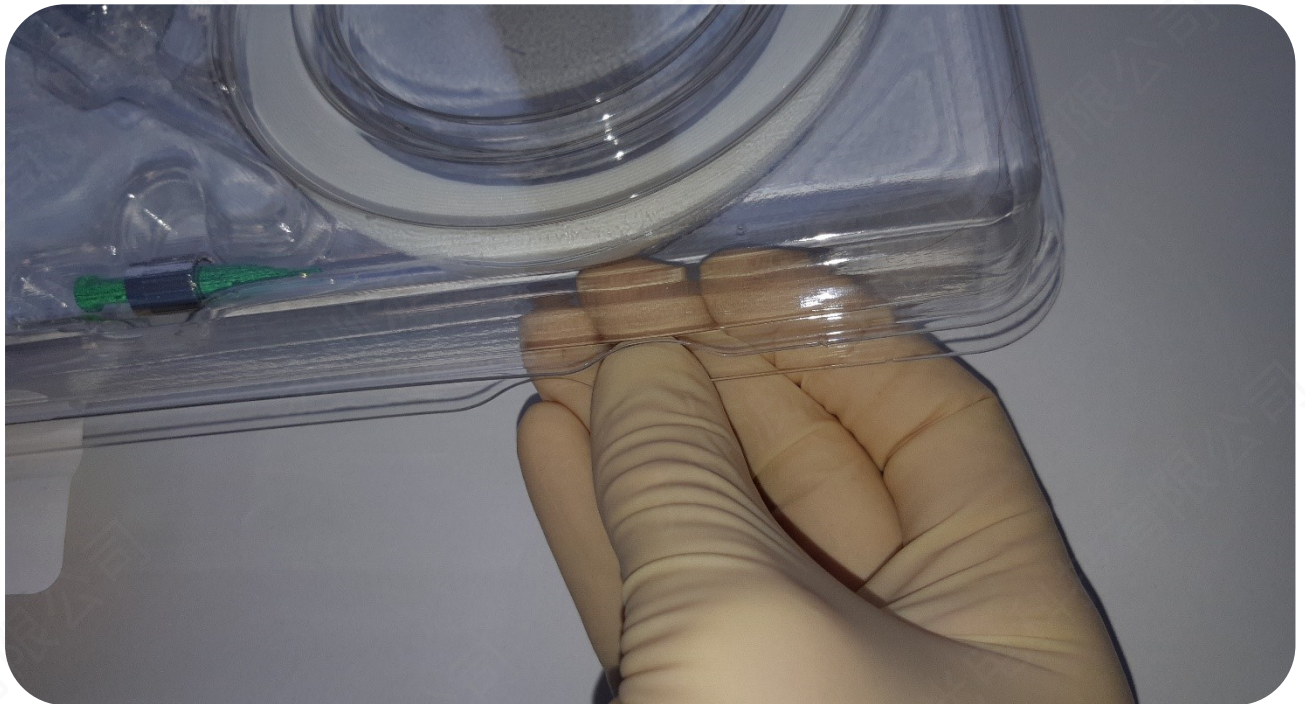

Fig. 4



Fig. 5

- 4) Delicately remove the “do not pull here” labels and place them on another part of the blister pack:

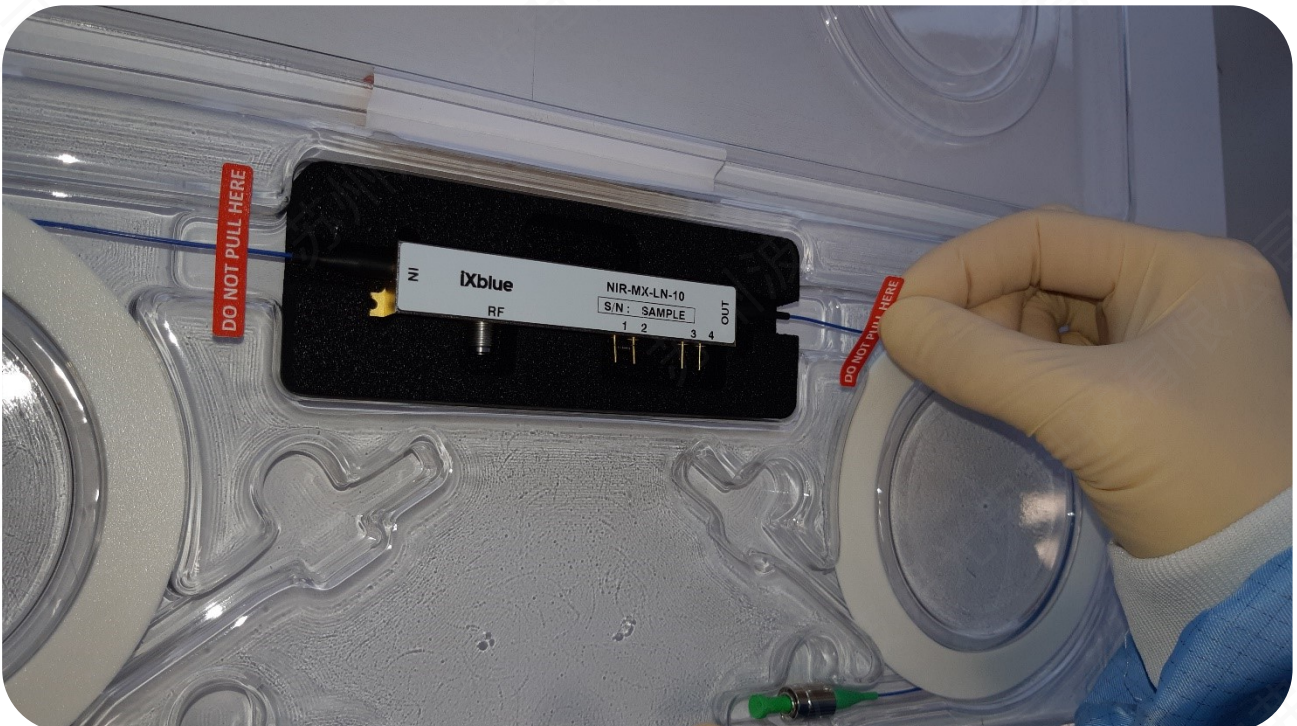

Fig. 6

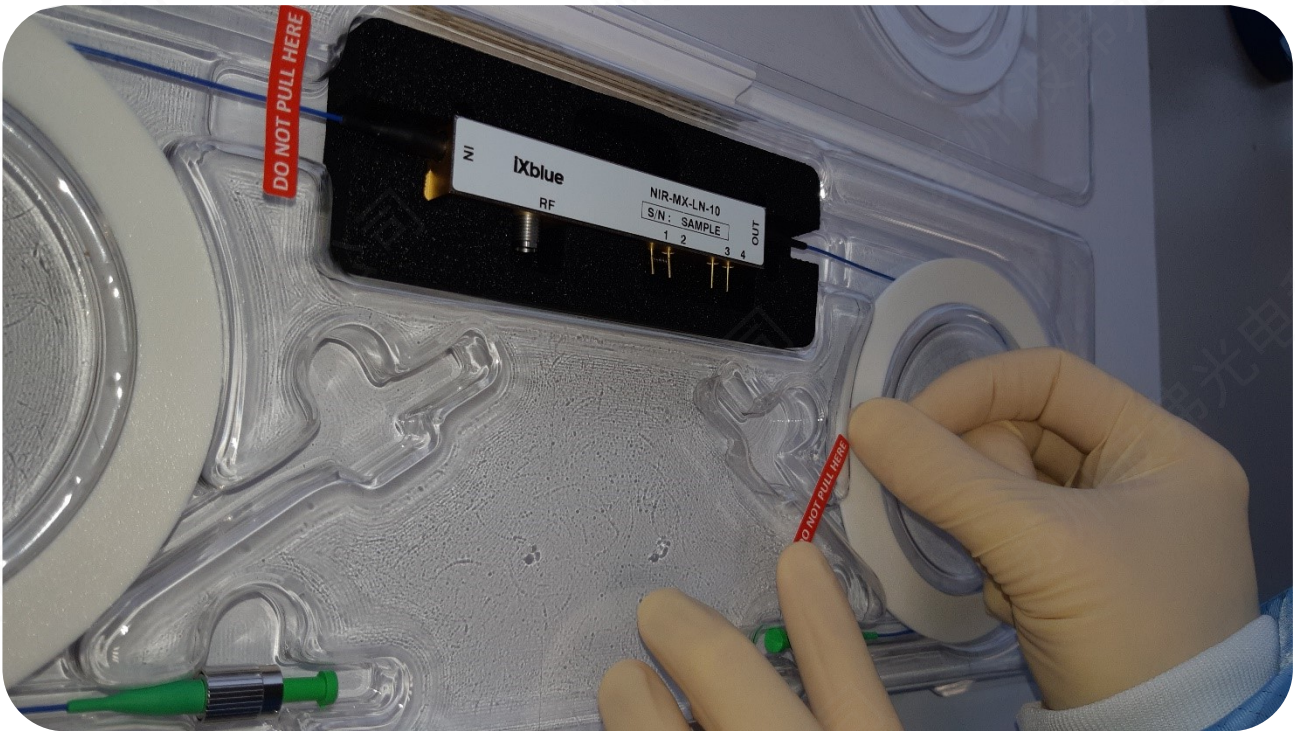

Fig. 7

- 5) Remove the optical connectors and take the fibers out of their tray. Lift and hold the modulator by its housing. Delicately pull it out, paying attention to the optical fibers: electrical pins and RF connector.

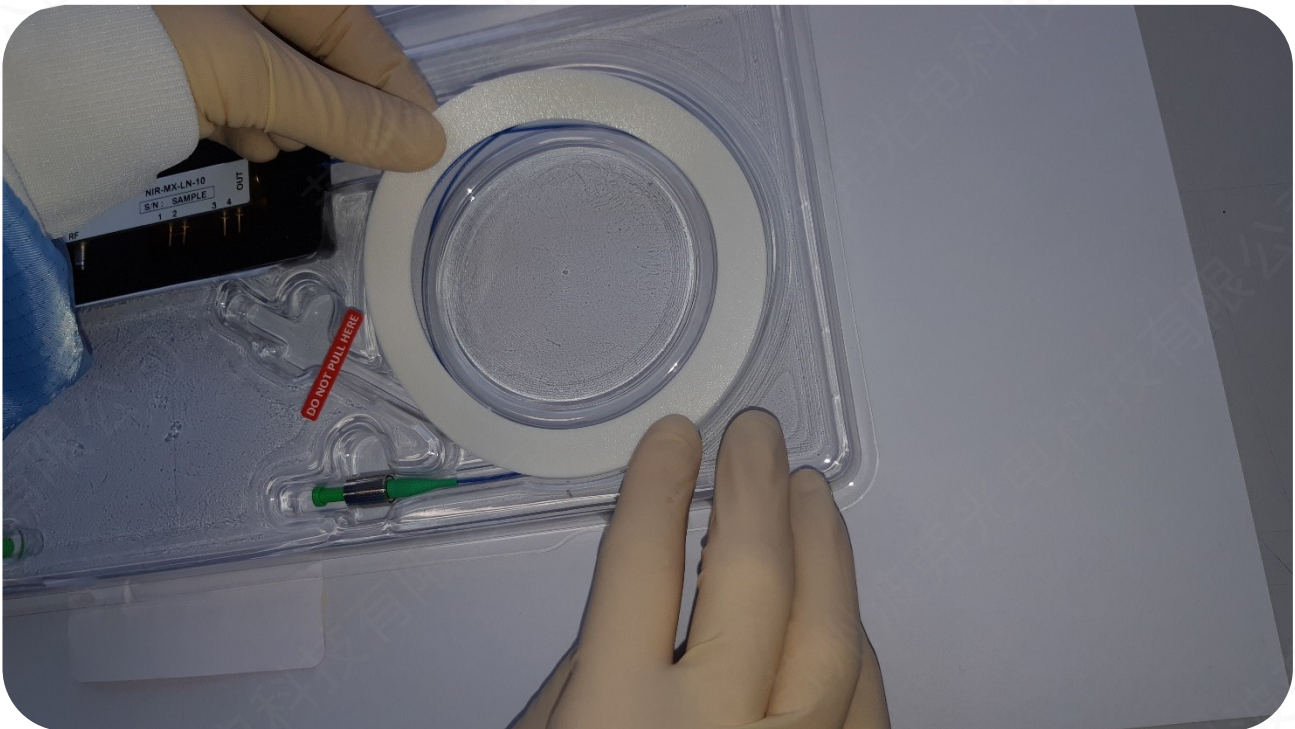

Fig. 8

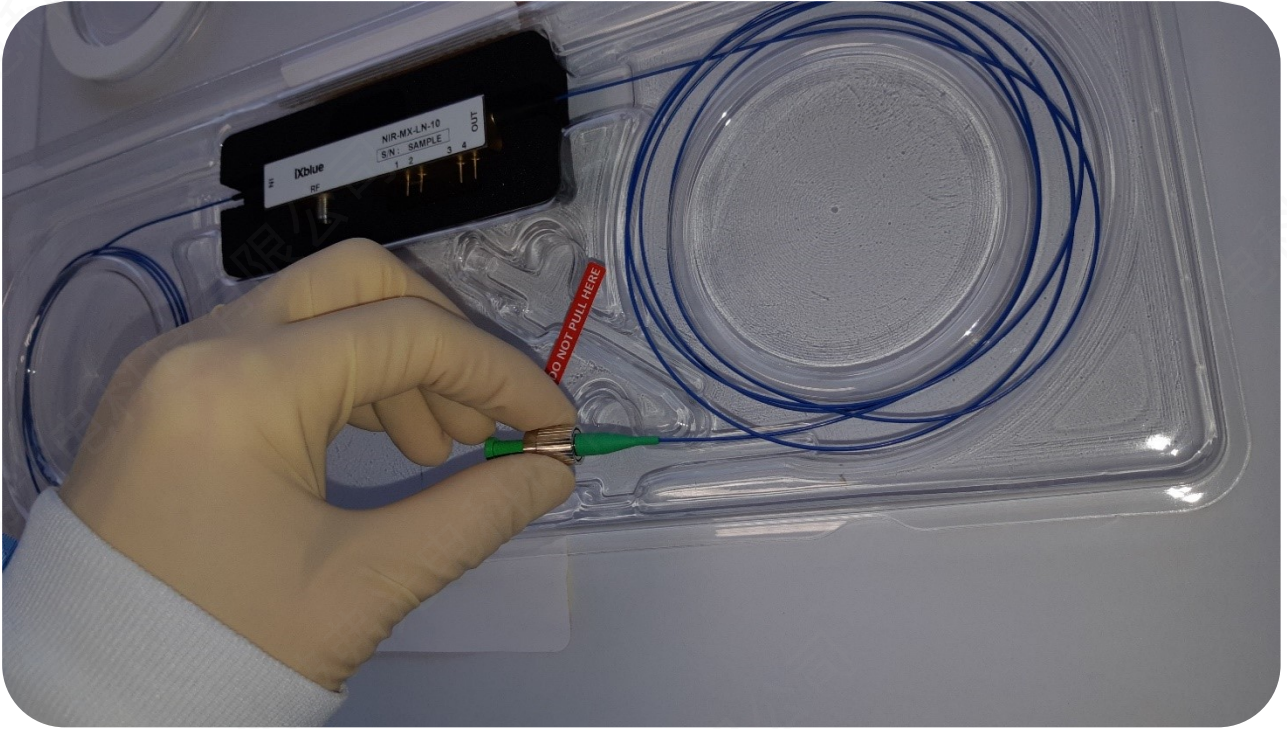

Fig. 9

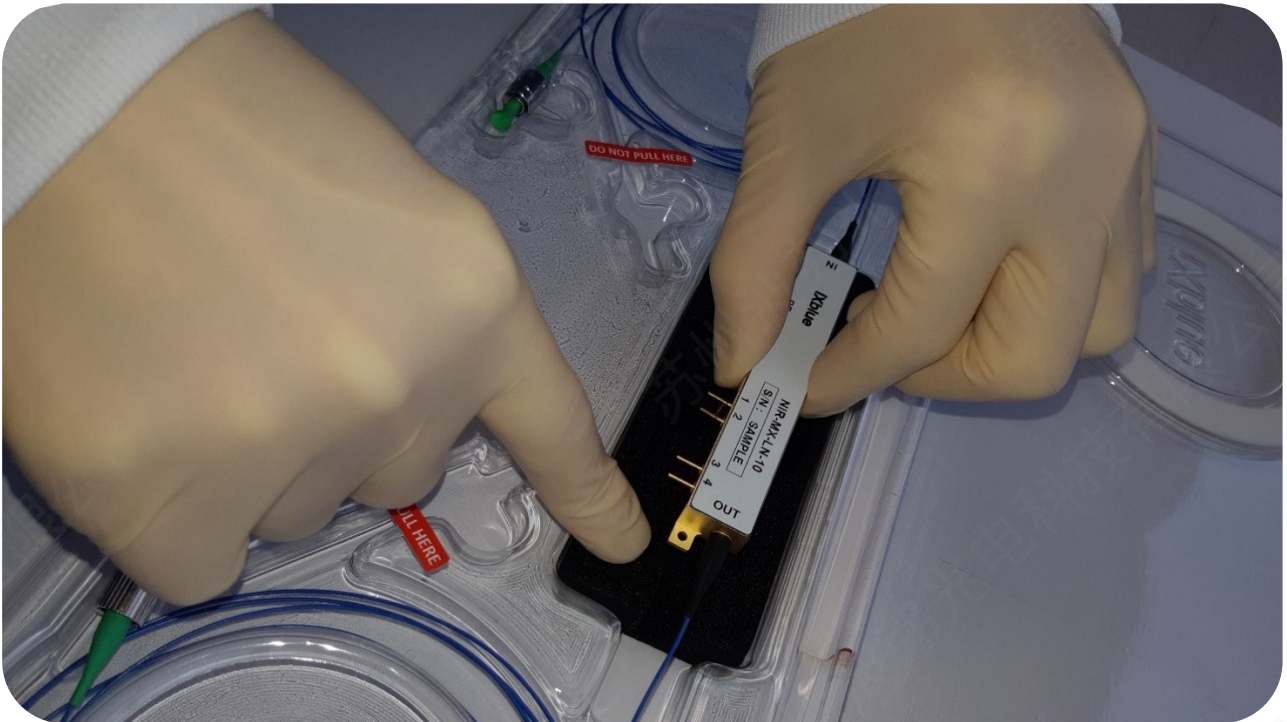

Fig. 10

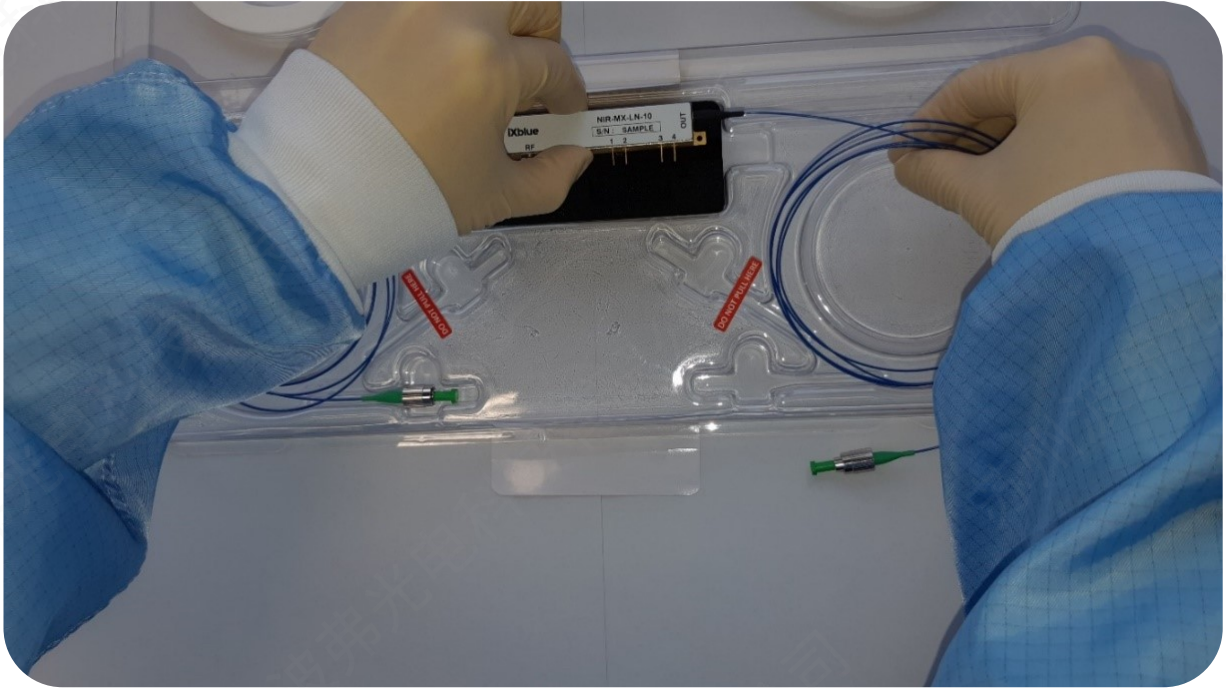

Fig. 11

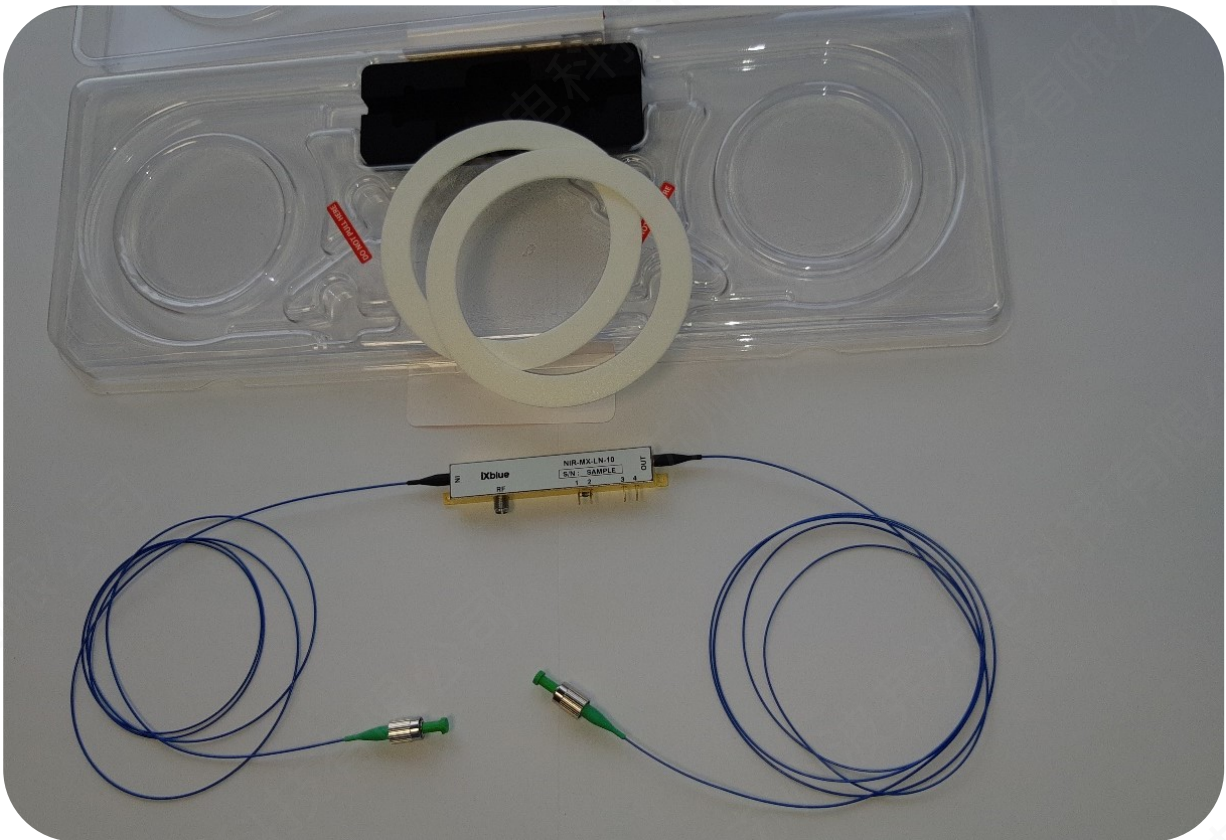

Fig. 12



6) Remove the spring located on the DC pin:



Fig. 13

7) Once the modulator is unpacked, you can use it.

- Remember to keep the blister pack if you need to store the modulator or send it back to us.
- To pack the modulator, repeat the previous unpacking steps from the end to the beginning. Do not forget to put the short circuit on DC pins (spring).

## 1.2 Warnings to avoid damage

**Never hold modulator:**

- by optical pigtails
- by pins or RF connector

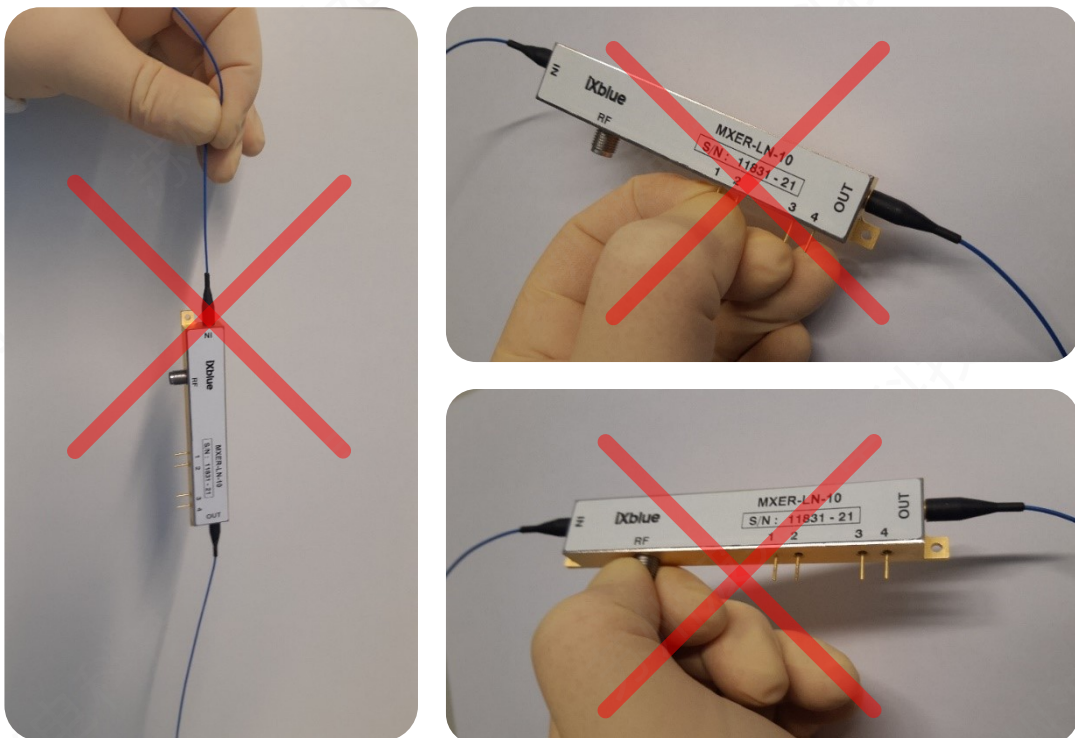

Fig. 14

## 2 Instructions before use

### 2.1 Cleaning

- We recommend manipulating the modulator with rubber gloves (or equivalent) and clean it with alcohol-soaked optical paper (or equivalent).
- Check optical connectors cleanliness: any dust could damage the connectors or degrade the optical parameters. Use specific wipes for cleaning optical connector, we recommend using Whatman® lens cleaning tissue, Grade 105, wetted with IPA.
- Clean RF connector with dry air before mating and use a torque wrench for tightening.

### 2.1 Optical interfaces

- Never pinch the fiber pigtail or apply instantaneous traction on it which could generate micro-cracks in the fibre silica.
- **Never bend or coil the fibre jacket under a radius of 30 mm.**

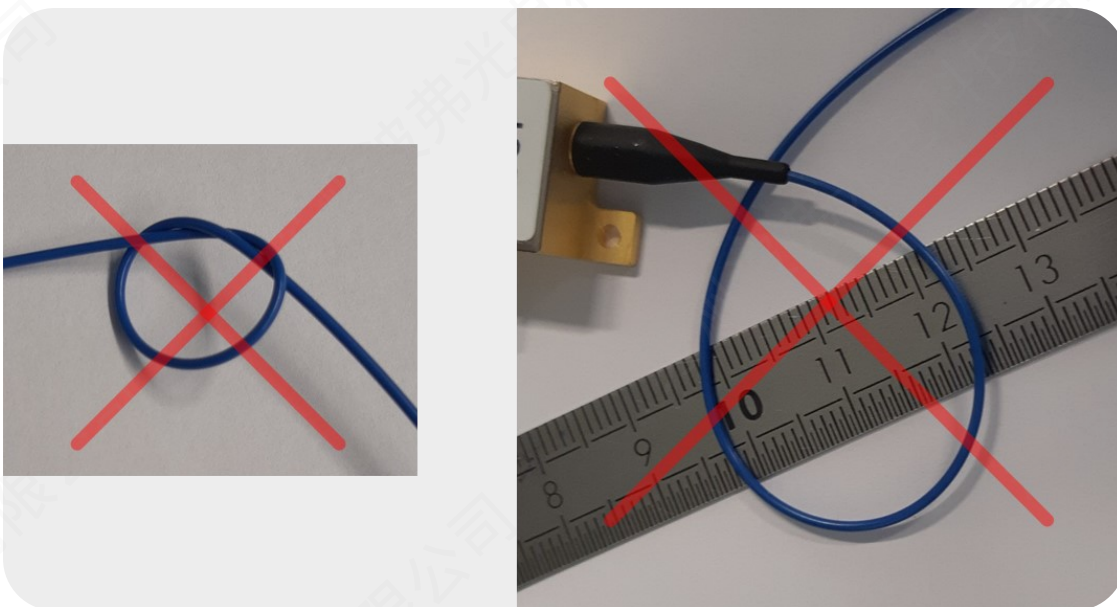

Fig. 15

- Pay attention to fiber bends, particularly with the 2000 nm series where any small radius bend could induce output optical power degradations.

- Check connectors compatibility:

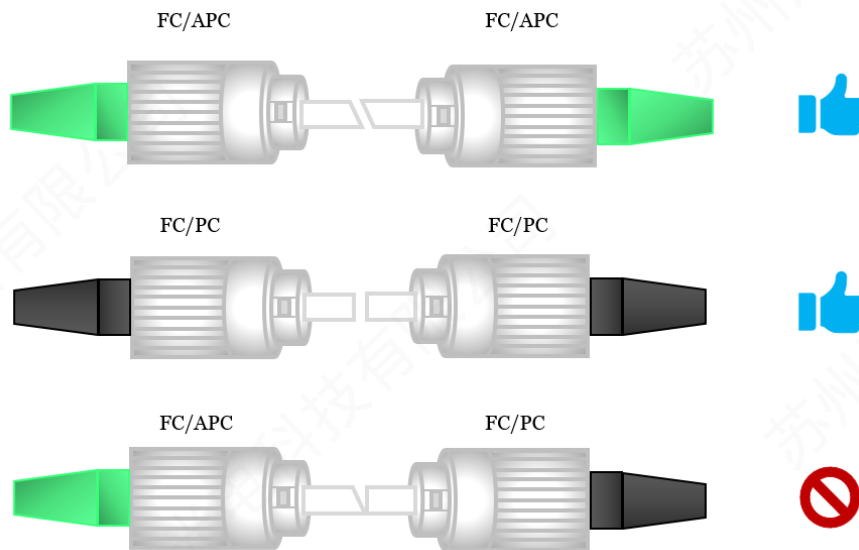

Fig. 16

- Avoid any shock on the housing, the fiber jacket or the optical connectors.
- Because Lithium Niobate crystal is naturally birefringent, LiNbO<sub>3</sub> modulators are polarization sensitive devices. The input light must be injected in the waveguide along a specific orientation, as accurately as possible. Therefore a Single Mode - SM - and Polarization Maintaining - PM - fiber is recommended at the input. If a SM fiber non PM is used, one must use a polarization controller to obtain the desired light orientation at the input of the modulator chip.
- Output Fiber: This will depend on your setup and the other components along the optical path. There is generally no drawback in using a PM output fiber, even when reconnecting to a SM fiber.
- Please also note that iXblue modulators:
  - are birefringent when operating in the O Band, C Band and 2 μm (TE and TM modes propagates with different properties).
  - Are polarizing for all Near Infra-Red operation or when the option “-Pol” (embedded and in-line polarizer) is selected for the O Band, C Band.

## 2.1 Electrical interfaces

The iXblue Photonics modulator comes with three kinds of electrical ports:

- 1) RF port: where the modulating signal is applied. Depending on the frequency range of application, three kinds of RF/microwave connectors are used:
  - 2.92 mm / K type, female, compatible to mate with SMA / 3.5 mm connectors.
  - 2.4 mm, female, compatible to mate with V / 1.85 mm connectors.
  - 1.85 mm / V type, female RF/microwave coaxial connector.
- 2) DC port: where a DC bias is applied to set the operating point of the intensity modulator. The DC connectors are gold plated pins ( $\varnothing$  0.76 mm).
- 3) Internal photodiode (PD) port: only used with intensity or IQ modulators. The connectors are gold plated pins ( $\varnothing$  0.76 mm).

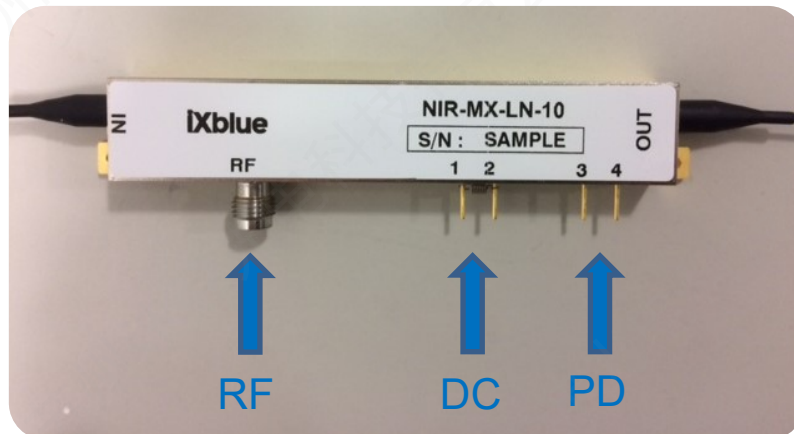

Fig. 17

### 2.1.1 RF CONNECTOR

- RF inputs must be connected with SMA rigid coax. @  $0.8 \text{ Nm} \leq \text{Torque} \leq 1.2 \text{ Nm}$



Fig. 18

### 2.1.2 DC / INTERNAL PHOTODIODE PINS

Although the DC port has been tested using the J-ATD 002D standard - test G, care must be taken when soldering the DC pins.

- For soldering gold-plated DC pins the use of a heat gun is not recommended as the excess heat may cause some internal damage. If soldering is necessary, we recommend the use of a 0.5 to 0.8 mm diameter copper wire previously stripped and wrapped around the pin. Then solder the wire to the pin with a 330°C to 350°C soldering iron equipped with a small clean soldering tip and a 0.23 mm diameter tin wire.
- Alternatively, we can recommend a pin receptacle that is sized perfectly for a nice snug fit onto those pins: PIN RECEPTACLE 0326 SERIES (Mill-Max Manufacturing Corp.). Accepted Diam. 0,56 mm - 0,81 mm.

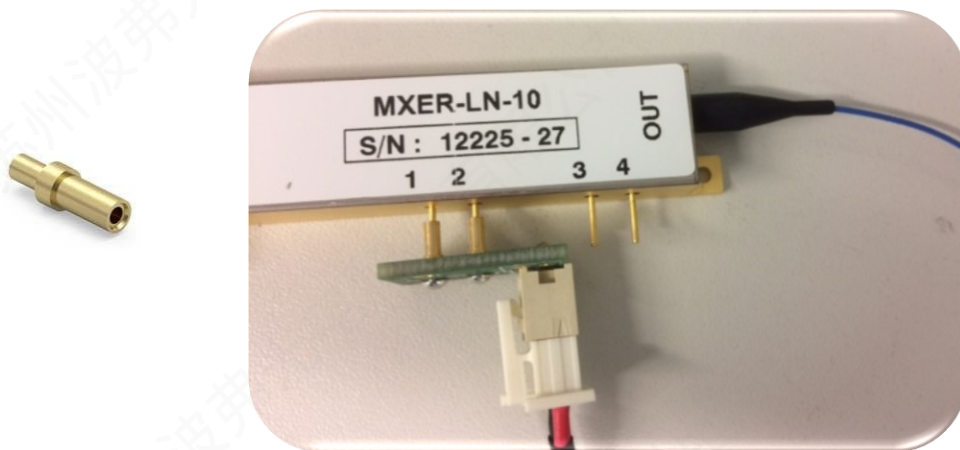

Fig. 19

### 2.1.3 INTERNAL PHOTODIODE PINS

- Take care to correctly connect the Anode / Cathode pins.

### 2.1.4 ELECTROSTATIC DISCHARGE (ESD)

Although the RF port has been tested Class 2 and the DC port Class 0 (MIL-STD-750E Method 1020.2), care must be taken to prevent ESD and other electrical stresses. Otherwise, delicate electrical structures inside the package could be damaged.

- We recommend unpacking or packing EOM in an Electrostatic Protected Area (EPA).
- Applying a transient overvoltage or any voltage above the specified maximum may cause a permanent damage to the modulator.

## 2.2 Maximum ratings

- Check optical, electrical, environmental maximum ratings available on our website.
- We strongly recommend splicing the fibers and avoid optical connectors when operating at high optical power levels (>100mW) and short wavelengths (1060 nm, 800 nm).

## 3 Measurement Parameters

This chapter describes the different set up used to measure each electrical or optical parameter of the modulator.

### 3.1 Insertion Loss (IL)

The insertion loss is defined by the difference between the modulator's input and output optical power (dBm):

$$IL(dB) = P_{ref}(dBm) - P_{out}(dBm)$$

The following sections describe the measurement set up when the modulator comes with (W/) or without (W/O) optical connectors.

#### 3.1.1 W/ OPTICAL CONNECTORS

##### 3.1.1.1 Reference measurement ( $P_{ref}$ ):



Fig. 20

##### 3.1.1.2 Intensity EOM max transmission measurement ( $P_{out}$ ):

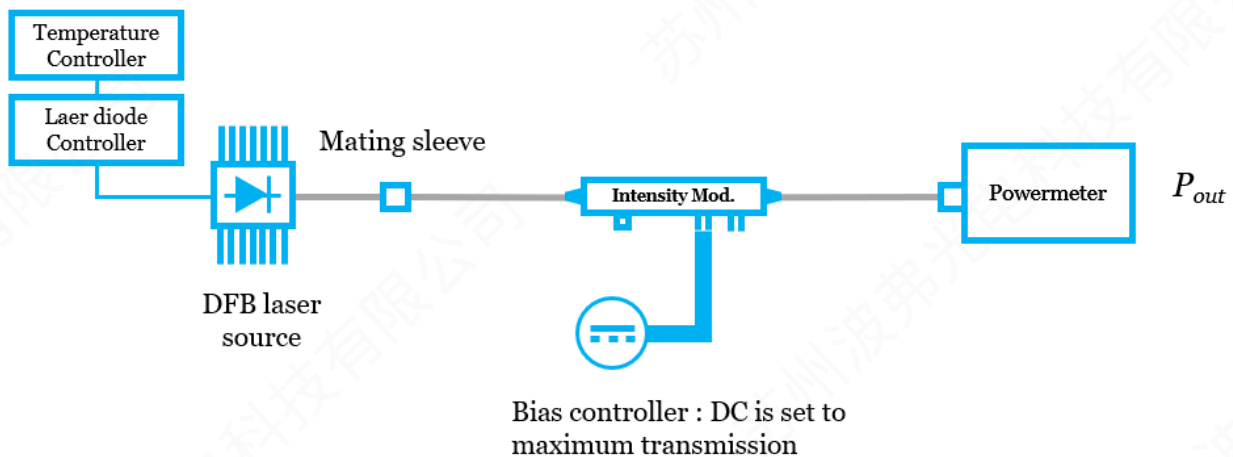

Fig. 21

3.1.1.3 Phase EOM transmission measurement ( $P_{out}$ ):

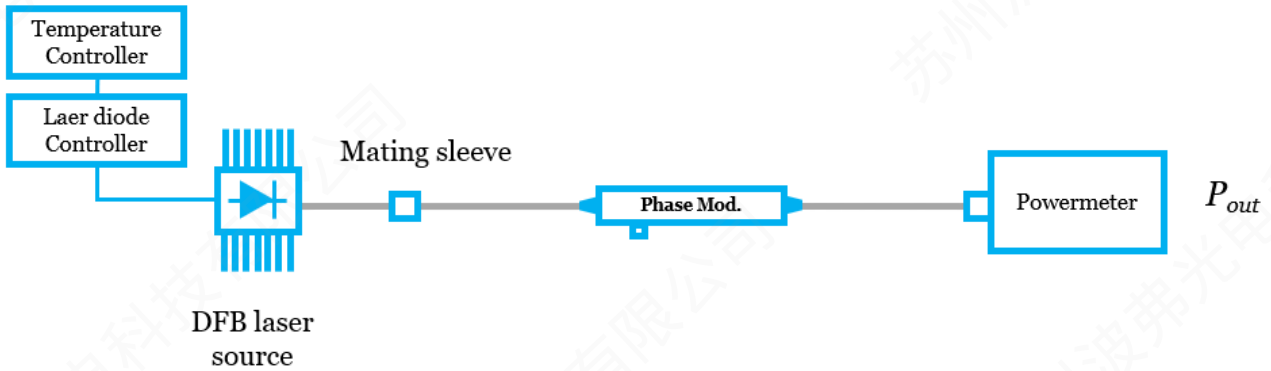

Fig. 22

Note: This measurement includes an uncertainty attributed to the optical connector's misalignment and mating sleeve.

Depending on the quality / compatibility of each optical element (connectors, mating sleeve), we estimate that the excess optical losses are as following:

FC/APC @1550 nm:  $\Delta IL \leq 0.25$  dB per connector

FC/APC @1060 nm:  $\Delta IL \leq 0.4$  dB per connector

FC/APC @850 nm:  $\Delta IL \leq 0.5$  dB per connector.

3.1.2 W/O OPTICAL CONNECTORS (CUT-BACK METHOD)

The cut-back method is a well-known set up to avoid the uncertainty induced by optical connectors. However, this method needs the use of a fiber fusion splicer equipment.

3.1.2.1 Reference measurement ( $P_{ref}$ ):

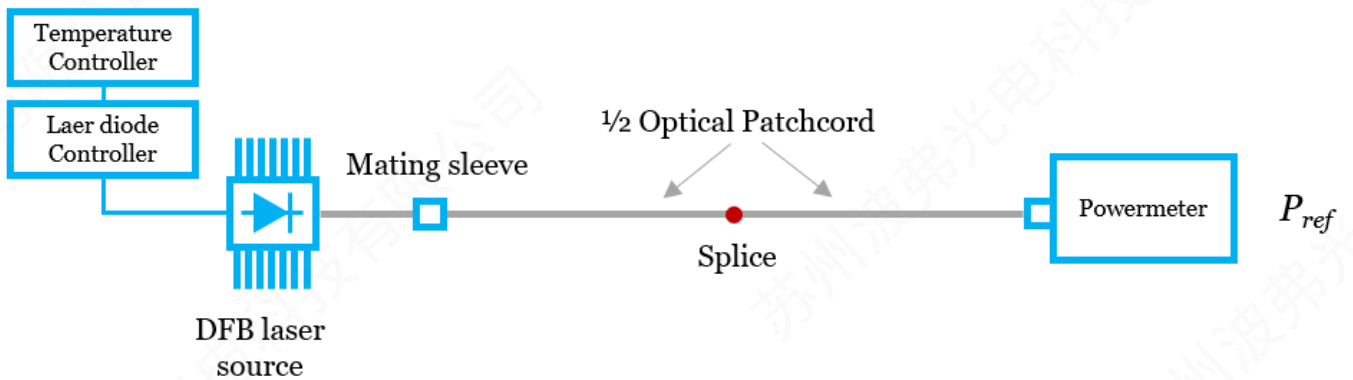

Fig. 23



3.1.2.2 Intensity EOM max transmission measurement ( $P_{out}$ ):

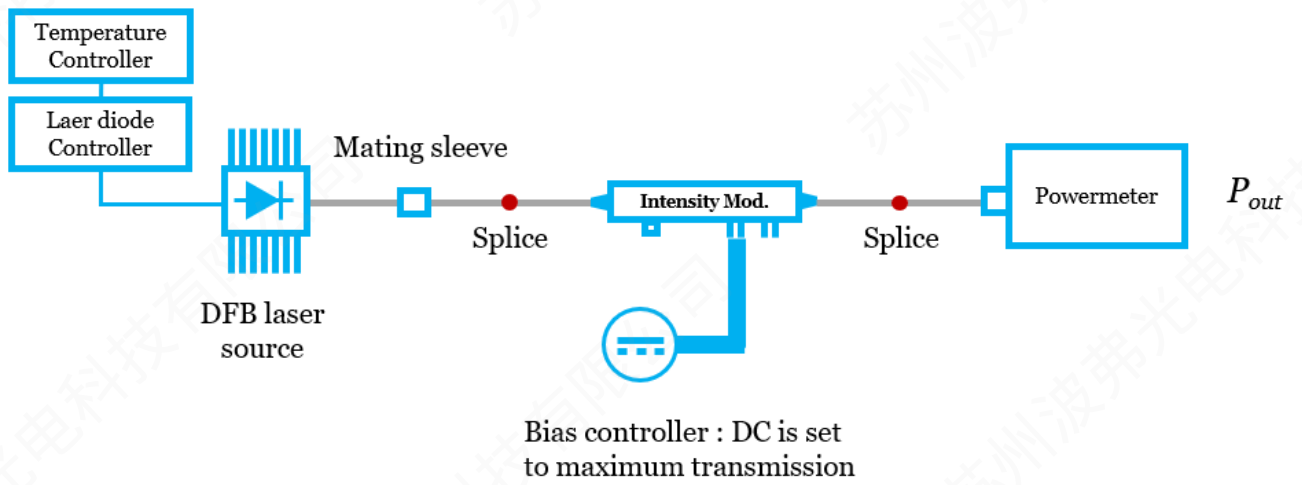

Fig. 24

3.1.2.3 Phase EOM transmission measurement ( $P_{out}$ ):

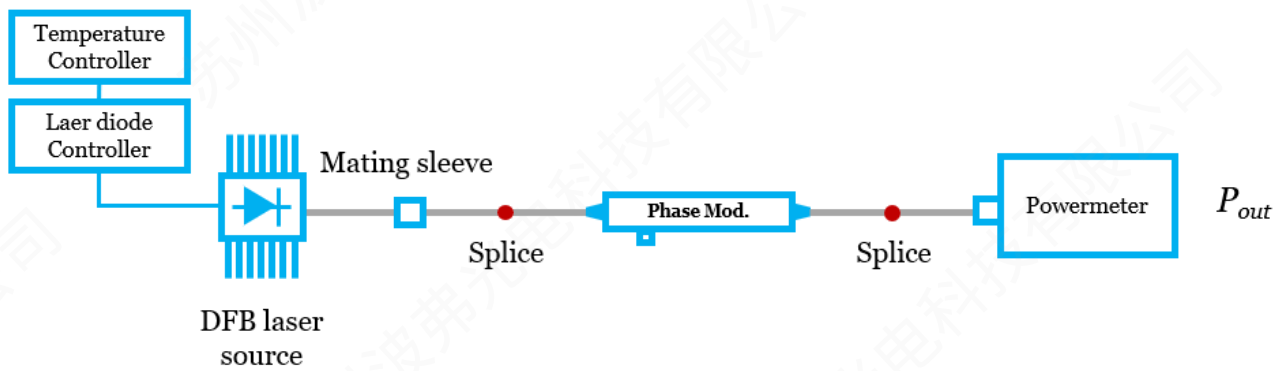

Fig. 25

Cut-back advantage: avoid uncertainty induced by optical connectors & mating sleeves (but still includes splices losses,  $\approx 0.01$  dB per splice).

### 3.2 Static Extinction Ratio (SER)

The static extinction ratio is defined as the maximum dynamic between the optical ON-state and OFF-state at the output of the intensity modulator:

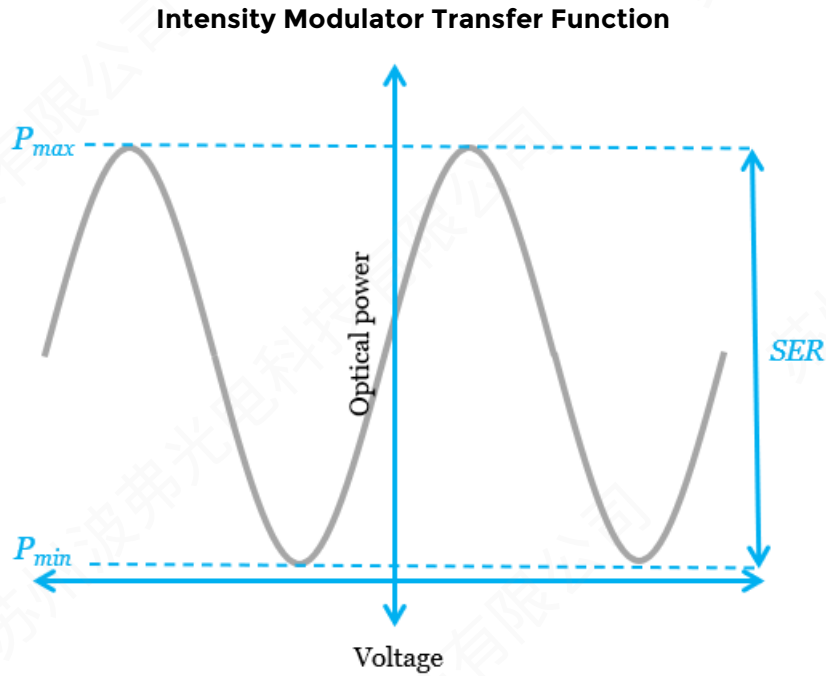
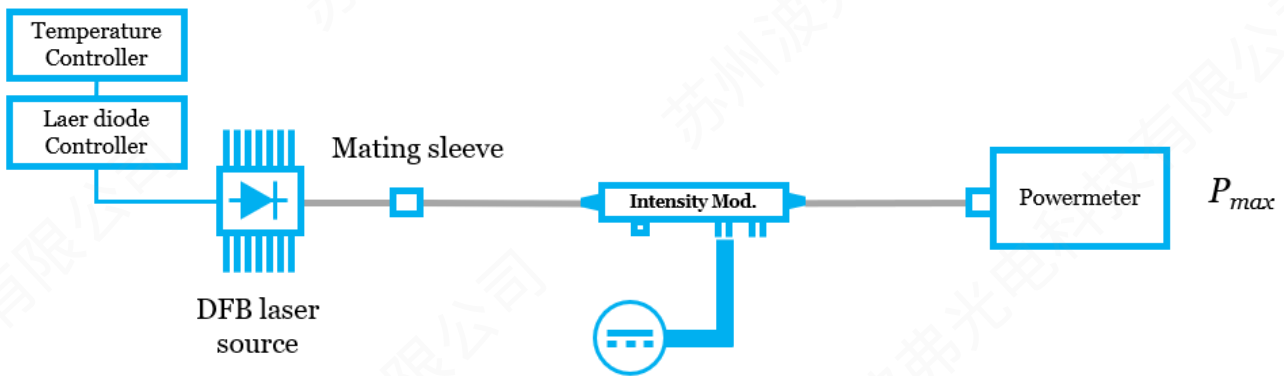

Fig. 26

$$SER(dB) = P_{max} (dBm) - P_{min} (dBm)$$

#### 3.2.1 EOM MAXIMUM TRANSMISSION MEASUREMENT ( $P_{MAX}$ ):



Bias controller : DC is set to maximum transmission

$P_{max}$  is set as reference on the powermeter

Fig. 27

### 3.2.2 EOM MINIMUM TRANSMISSION MEASUREMENT ( $P_{min}$ ):

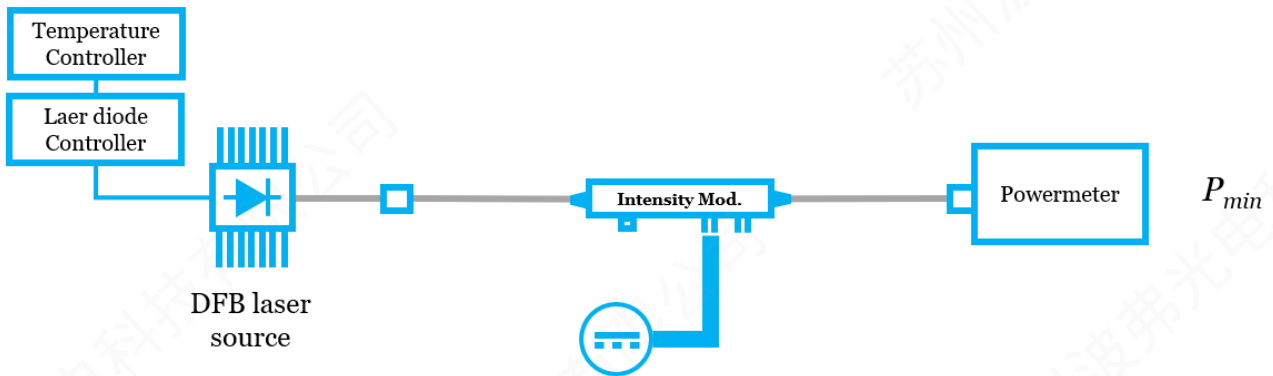

Bias controller : DC is adjust to reach minimum transmission

Fig. 28

Note: The DC voltage applied to adjust  $P_{min}$  can be positive or negative. We recommend selecting the voltage corresponding to  $P_{min}$  that is closest to zero in order to minimize DC-drift.

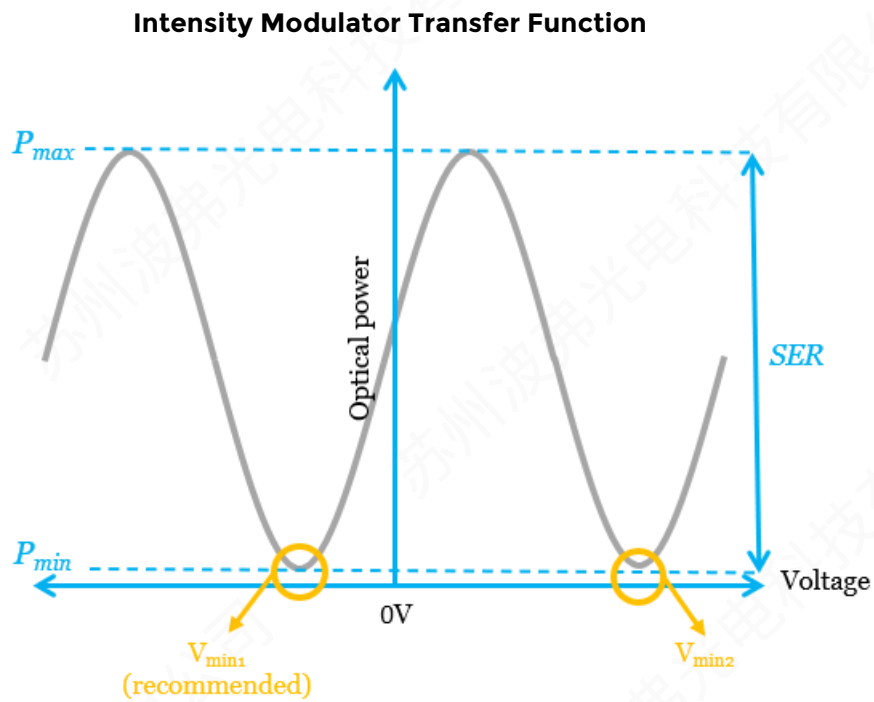

Fig. 29

### 3.3 Half-wave voltage ( $V_{\pi}$ ) at low frequencies (kHz)

The half-wave voltage ( $V_{\pi}$ ), is the voltage needed to induce a  $\pi$  phase shift on the optical wave. With the intensity modulator, which is a two-wave interferometer, it corresponds to the driving voltage necessary to vary the optical output from the maximum of power to the minimum of power (see the Modulator Transfer Function, MTF):

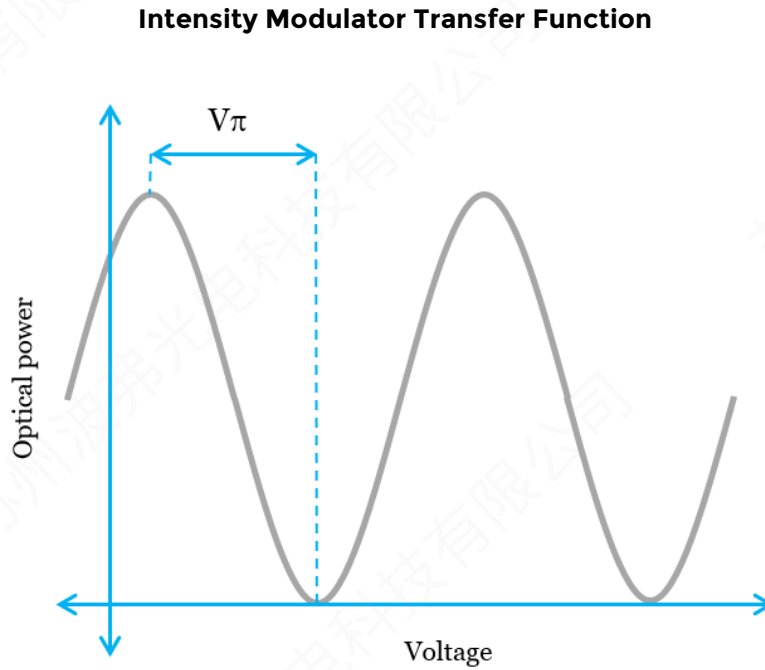

Fig. 30

#### 3.3.1 $V_{\pi}$ DC MEASUREMENT SET UP (DC ELECTRICAL PORT)

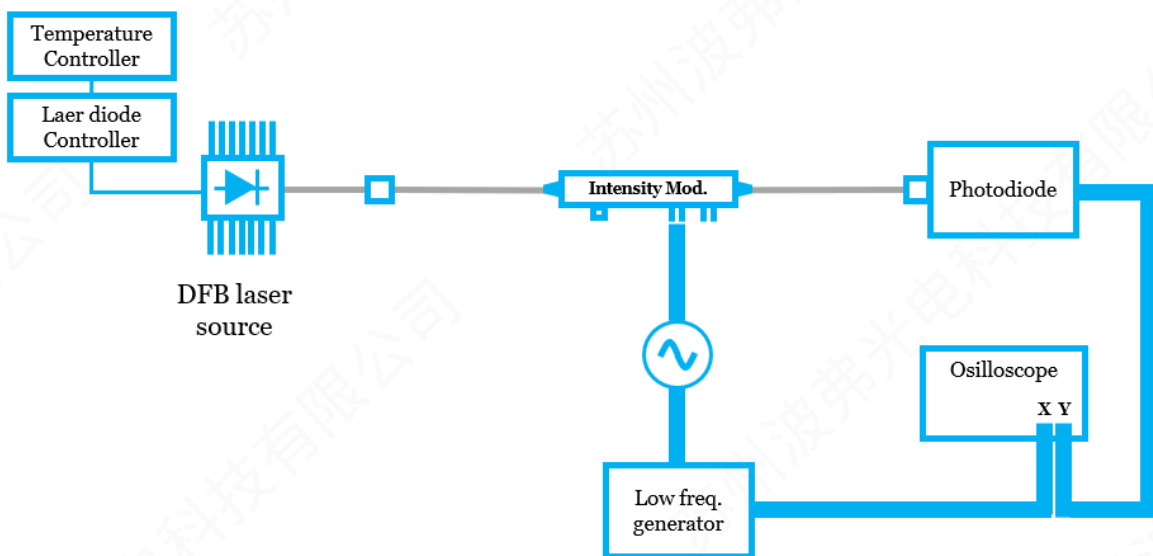

Fig. 31

### 3.3.2 $V_{\pi}$ RF MEASUREMENT SET UP (RF ELECTRICAL PORT)

#### 3.3.2.1 Intensity Modulator

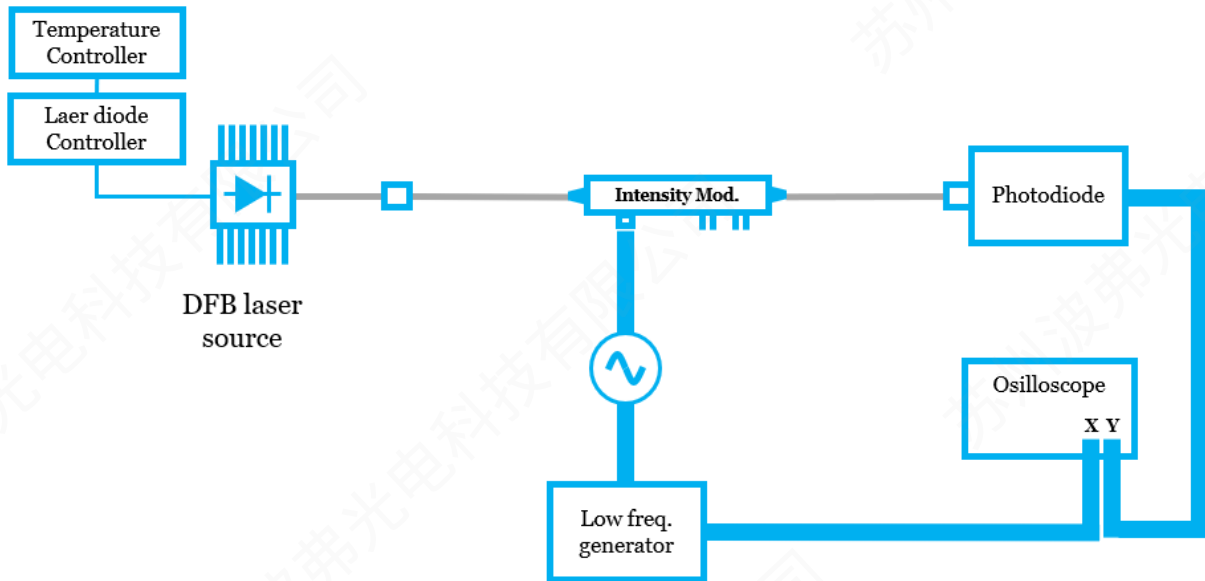

Fig. 32

#### 3.3.2.2 Phase Modulator

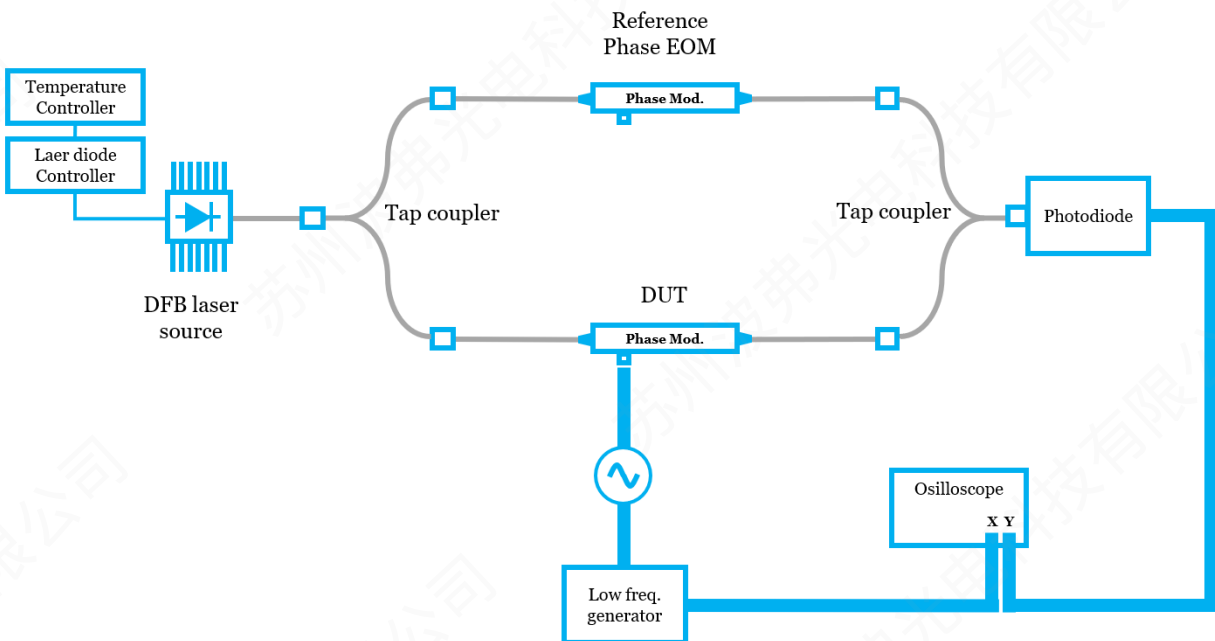

Fig. 33

Note: Reference Phase EOM & DUT must have similar insertion losses to recreate a balanced MZ interferometer.

### 3.4 Residual Amplitude Modulation (RAM)

The purpose of any phase modulator is to modulate the phase of light. On an integrated optical structure like a Lithium Niobate modulator, a perfect phase modulation is true in theory, but also yields to undesired side effects. Indeed, the optical phase modulation yields a very weak optical amplitude modulation. The residual amplitude modulation parameter (dB) is defined by the ratio of the measured AC to DC intensity components at the optical output of the modulator (see the following set up and graph):

$$RAM = 10 \times \log_{10} \left( \frac{\text{Amplitude}}{\text{Max. amplitude}} \right)$$

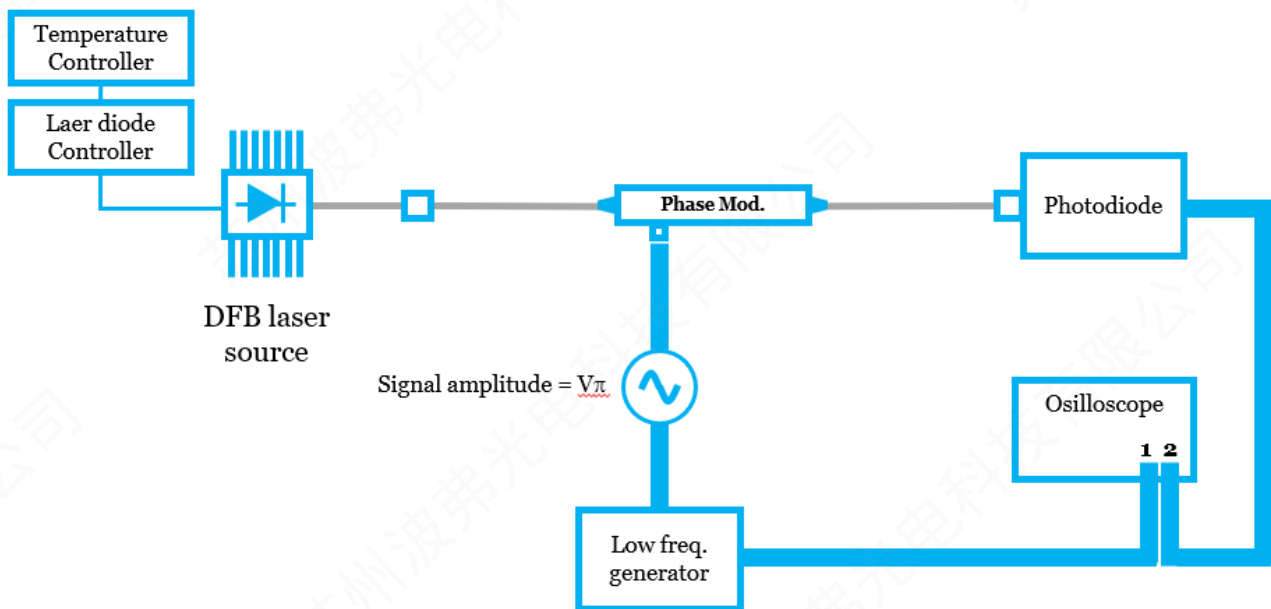

Fig. 34

**Phase Modulator Response in Time**

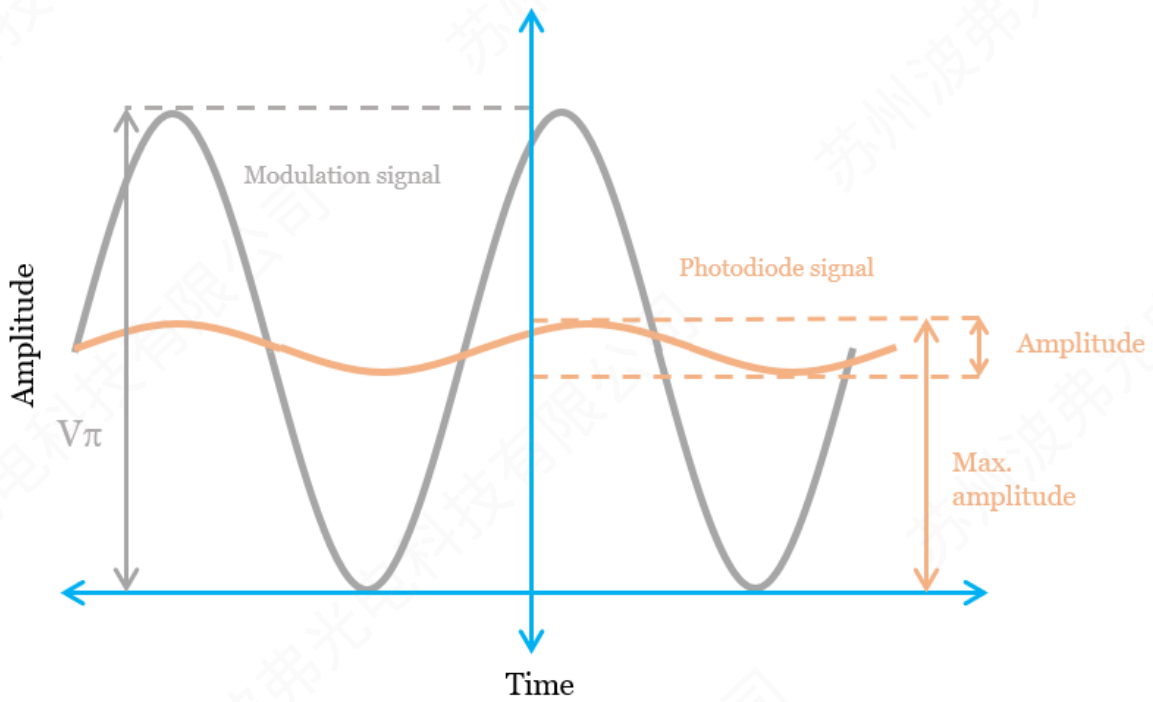

Fig. 35

### 3.5 Polarization Extinction Ratio (PER)

The modulator's best electro-optical efficiency is obtained when the light is linearly polarized along the Z axis of the crystal (TM-polarized light for Z-cut or TE-polarized light for X-cut). Therefore, it means that a majority of the integrated optical components come with polarization maintaining (PM) fibers (PANDA type).

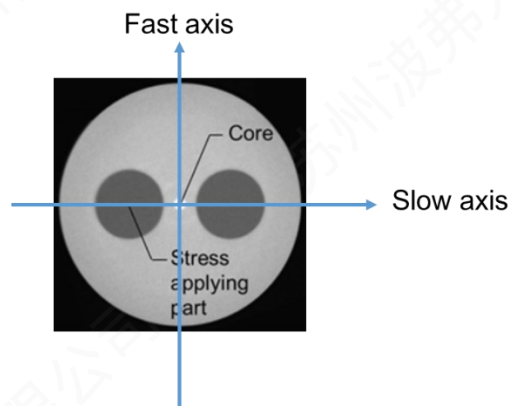
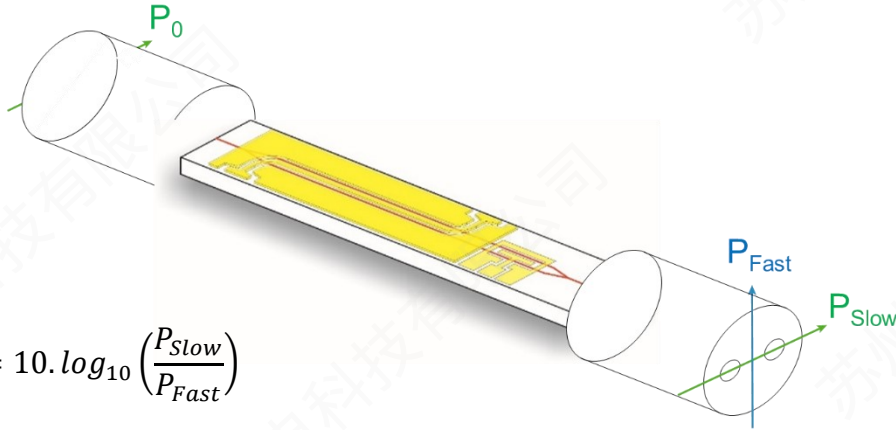

Fig. 36

The PER is the optical power ratio between the two main polarization axis (slow/fast) measured at the PM output of the modulator. We measure the PER of the modulator by injecting a linearly polarized light on one axis only and then measuring the optical power on each axis  $P_{Fast}$  and  $P_{Slow}$ .



$$PER(dB) = 10 \cdot \log_{10} \left( \frac{P_{Slow}}{P_{Fast}} \right)$$

Fig. 37

For this set up, a broadband source like an ASE or SLED coupled with a polarizer is used. The use of such a light source ensures a stable PER measurement:

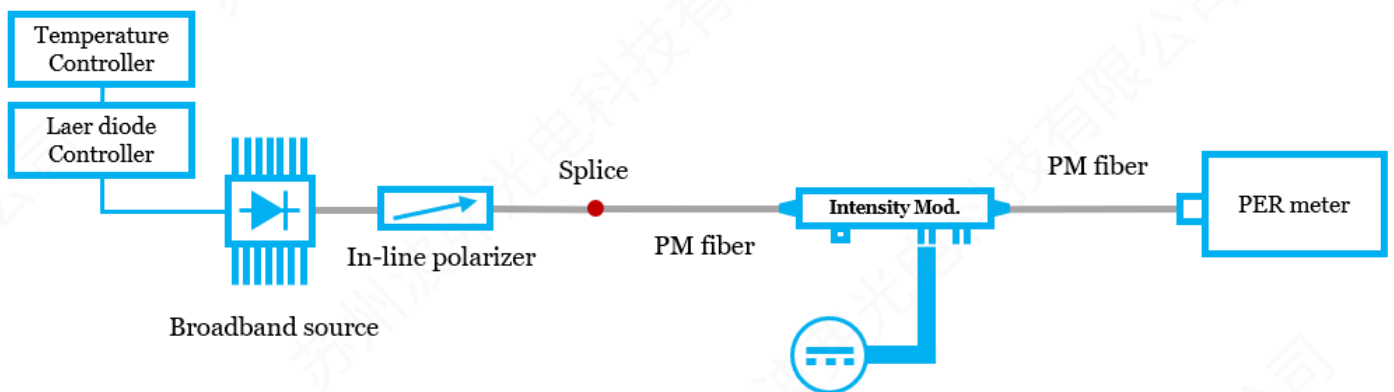

Bias controller : DC is set to maximum transmission

Fig. 38

→ PER is read directly on the PER meter (rotating polarizer).

A narrow linewidth laser such as a DBF can also be used to measure PER. However, with such a highly coherent source, if a fraction of the polarization travels along the wrong axis, any stress on the fiber (ex: temperature change) will directly affect the phase relation between the slow and fast axes in the PM fiber and therefore the PER, in a time dependent manner. In order to evaluate the worst situation, you need to apply some stress on the output fiber and record the lowest PER:



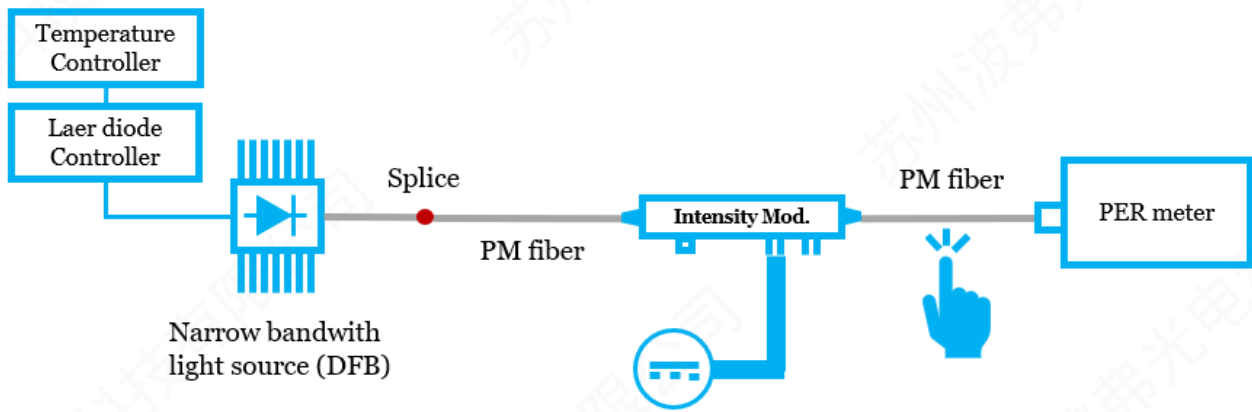

Fig. 39

**Notes:**

Optical connectors are usually the first root cause of PER degradation because of the misalignment between the PM fiber axes and the connector key.

In a same way, a bad mechanical tolerance with the mating sleeves can be a cause of PER instabilities and degradation. Some manufacturers propose mating sleeves with a better mechanical tolerance, for high PER applications.

### 3.6 Polarization Dependent Loss (PDL)

The PDL is the optical loss difference (dB) between the two main polarization axes when light is injected into the modulator. This parameter is particularly relevant to the polarization switch and the polarization scrambler modulator.

On LiNbO<sub>3</sub> chips, PDL is the optical loss difference between TE & TM polarization states (dB) for the respective optical input powers P<sub>1</sub> & P<sub>2</sub> (in dBm):

$$\alpha_{TE}(dB) = 10 \cdot \log_{10} \left( \frac{P_{TE}}{P_1} \right)$$

$$\alpha_{TM}(dB) = 10 \cdot \log_{10} \left( \frac{P_{TM}}{P_2} \right)$$

$$PDL(dB) = \alpha_{TE}(dB) - \alpha_{TM}(dB)$$

$$\text{if } P_1=P_2, \quad PDL(dB) = 10 \cdot \log_{10} \left( \frac{P_{TE}}{P_{TM}} \right)$$

$$PDL(dB) = P_{TE}(dBm) - P_{TM}(dBm)$$

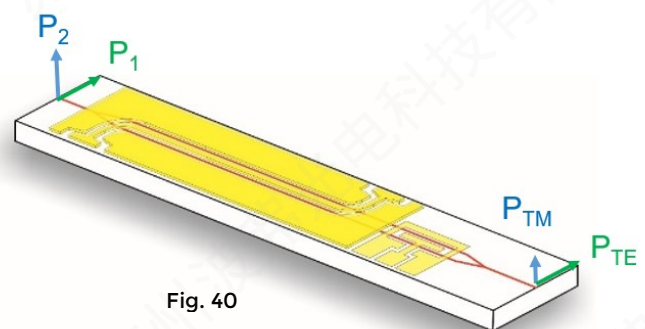

Fig. 40

The following set up explains how to measure it:

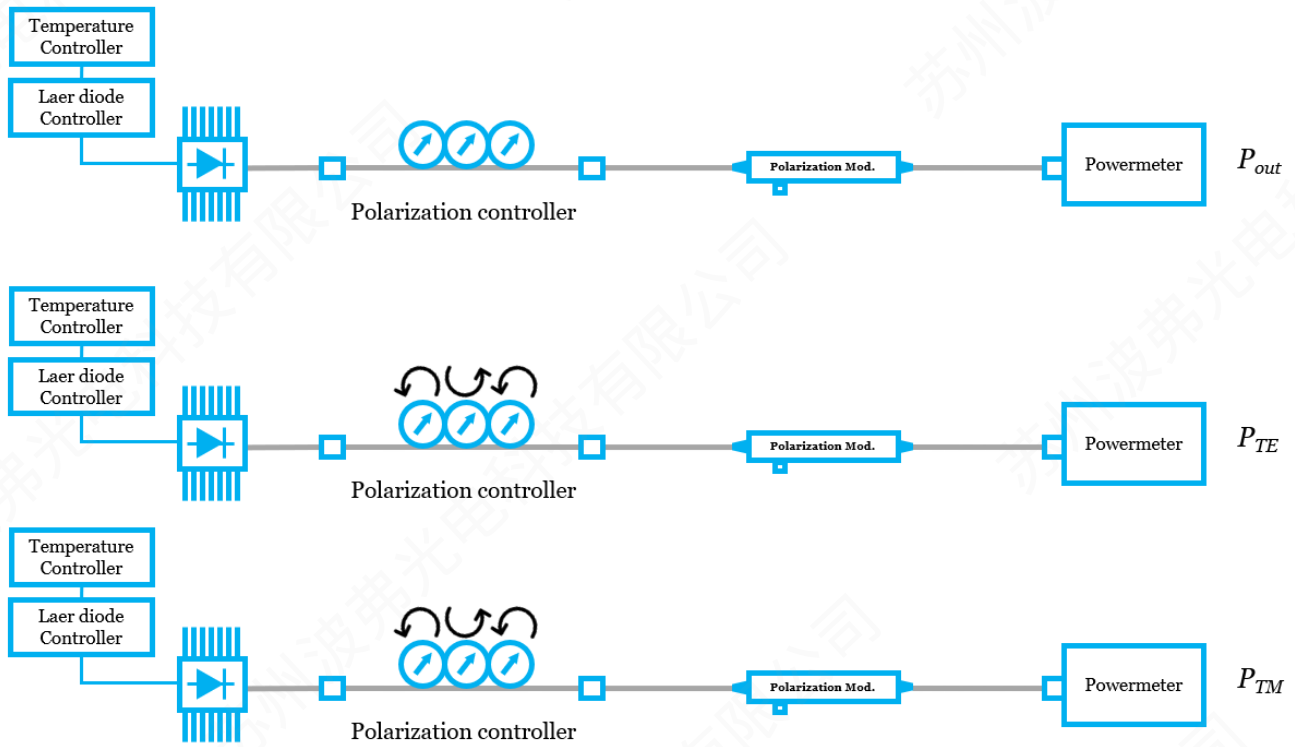

Fig. 41

$P_{TE}$  &  $P_{TM}$  are obtained by varying the input light polarization state with a polarization controller.

### 3.7 Electrical return loss $S_{11}$ & electro-optical bandwidth $S_{21}$

The high frequency efficiency of the RF port is generally given by the electrical return loss and the electro-optical transmission values.

These parameters are measured with some high-speed instruments such as photodiode and Vectorial Network Analyzer:

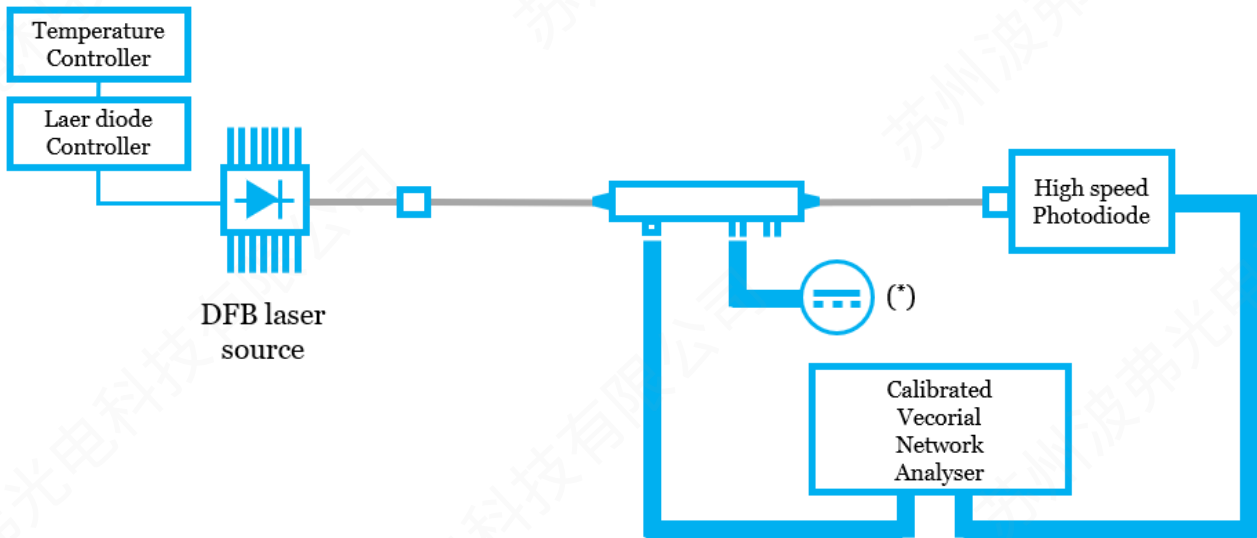

(\* ) DC is adjusted to reach quad transmission (small signal to linearity slope of MTF)

Fig. 42

Electro-optical bandwidth ( $S_{21}$ )

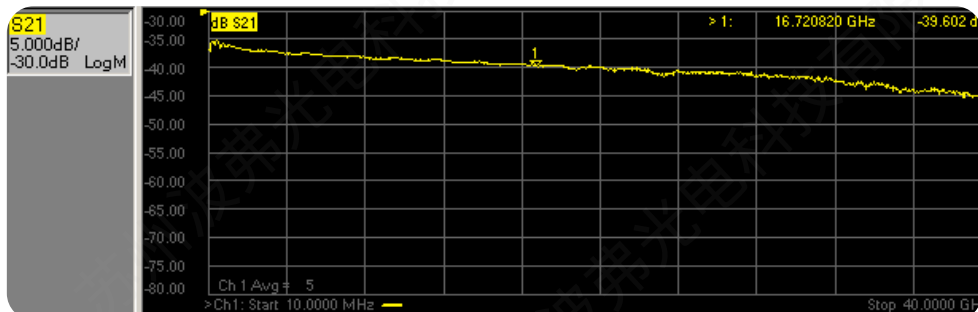

Electrical reflexion ( $S_{11}$ )

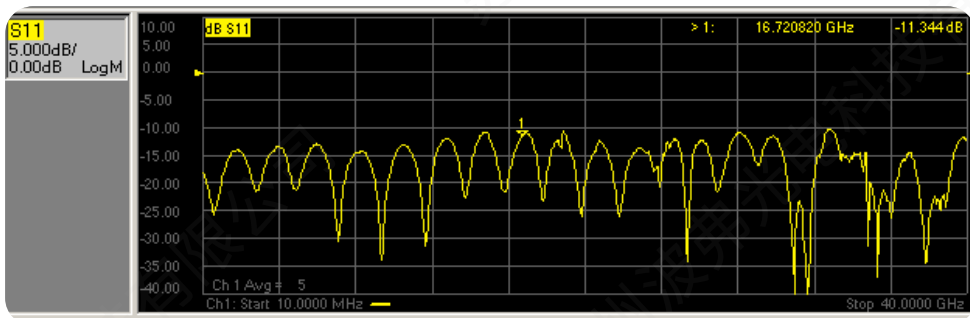

Fig. 43